

1	EN	Instruction Manual	DC Power Supply
2	DE	Bedienungsanleitung	DC Stromversorgung
3	FR	Manual d'instructions	DC Alimentation d'Énergie
4	ES	Manual de instrucciones	DC Fuente De Alimentación
5	IT	Manuale di Istruzione	DC Gruppo di alimentazione
6	PT	Manual de Instruções	DC Fonte De Alimentação

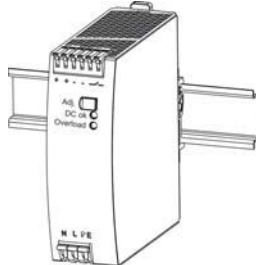

PULS
DIMENSION
 QS5 Series

Read first !

English **1**

Before operating this unit please read this manual thoroughly. Retain this manual for future reference! The power supply may only be installed and put into operation by qualified personnel.
 Intended Use:
 This device is designed for installation in an enclosure and is intended for the general use such as in industrial control, office, communication, and instrumentation equipment. Do not use this device in aircrafts, trains and nuclear equipment where malfunction of the power supply may cause severe personal injury or threaten human life.

<p>⚠ WARNING !</p> <p>Risk of electrical shock, fire, personal injury or death.</p> <p>(1) Do not use the unit without proper grounding (Protective earth) (2) Turn power off before working on the power supply. Protect against inadvertent repowering. (3) Make sure of the wiring is correct by following all local and national codes. (4) Do not modify or repair the unit. (5) Do not open the unit as high voltages are present inside. (6) Use caution to prevent any foreign objects from entering into the housing. (7) Do not use in wet locations. (8) Do not use the unit in area where moisture or condensation can be expected</p>	<p>⚠ CAUTION !</p> <p>Reduction of output power may be necessary when:</p> <p>(1) Minimum installation clearance can not be met (2) Altitudes higher than 2000m (3) Power supply is used above 60°C ambient (4) Mounting orientation is other than input terminal located at the bottom and output at the top. (5) Airflow for convection cooling is obstructed</p> <p>Details for de-rating can be found in this manual.</p> <p>Do not touch during power-on, and immediately after power-off. Hot surface may cause heat injury. The unit does not contain a service parts. The tripping of an internal fuse is caused by an internal defect. If damage or malfunction should occur during operation, immediately turn power off and send unit for inspection to the factory!</p>
--	--

The information presented in this document is believed to be accurate and reliable and may change without notice. The English text applies in cases of doubt.

Notes for use in hazardous locations	<p>WARNING EXPLOSION HAZARDS</p> <p>Units which are marked with "Class I Div 2" are suitable for use in non-hazardous or Class I Division 2 Groups A, B, C, D locations only. Substitution of components may impair suitability for Class I Division 2 environment. Do not disconnect equipment unless power has been switched off. Wiring must be in accordance with Class I, Division 2 wiring methods of the National Electrical Code, NFPA 70, and in accordance with other local or national codes.</p>
--------------------------------------	---

Vor Inbetriebnahme lesen !

Deutsch **2**

Bitte lesen Sie diese Warnungen und Hinweise sorgfältig durch bevor Sie die Stromversorgung in Betrieb nehmen. Bewahren Sie die Anleitung zum Nachlesen auf. Die Stromversorgung darf nur durch fachkundiges und qualifiziertes Personal installiert werden.

Bestimmungsgemäßer Gebrauch:
 Dieses Gerät ist für den Einbau in ein Gehäuse konzipiert und zur Verwendung für allgemeine elektronische Geräte, wie z.B. Industriesteuerungen, Bürogeräte, Kommunikationsgeräte oder Messgeräte geeignet. Benutzen Sie dieses Gerät nicht in Steuerungsanlagen von Flugzeugen, Zügen oder atomaren Einrichtungen, in denen eine Funktionsstörung zu schweren Verletzungen führen oder Lebensgefahr bedeuten kann.

<p>⚠ WARNUNG !</p> <p>Missachtung nachfolgender Punkte kann einen elektrischen Schlag, Brände, schwere Unfälle oder Tod zur Folge haben.</p> <p>(1) Betreiben Sie die Stromversorgung nie ohne Schutzleiter! (2) Schalten Sie die Netzspannung vor Installations-, Wartungs- oder Änderungsarbeiten ab und sichern Sie gegen unbeabsichtigtes Wiedereinschalten. (3) Sorgen Sie für eine ordnungsgemäße und fachgerechte Verdrahtung. (4) Führen Sie keine Änderungen oder Reparaturversuche am Gerät durch. (5) Gerät niemals öffnen. Im Inneren befinden sich gefährliche Spannungen. (6) Verhindern Sie das Eindringen von Fremdkörpern, wie z.B. Büroklammern und anderen Metallteilen. (7) Betreiben Sie das Gerät nicht in feuchter Umgebung. (8) Betreiben Sie das Gerät nicht in einer Umgebung, bei der mit Betauung oder Kondensation zu rechnen ist.</p>	<p>⚠ VORSICHT !</p> <p>Rücknahme der Ausgangsleistung kann erforderlich sein:</p> <p>(1) wenn die minimalen Einbaubstände nicht eingehalten werden können. (2) bei Aufstellhöhen über 2000m. (3) Betrieb bei Umgebungstemperaturen über 60°C. (4) bei Einbaulagen abweichend von der Standardeinbaulage (Eingang unten, Ausgang oben). (5) bei behinderter Luftzirkulation.</p> <p>Weitere Informationen zur Leistungsrücknahme befinden sich in dieser Betriebsanleitung.</p> <p>Gehäuse nicht während des Betriebes oder kurz nach dem Abschalten berühren. Heiße Oberflächen können Verletzungen verursachen. Das Gerät beinhaltet keine Servicebauteile. Interne Sicherungen lösen nur bei Gerätedefekt aus. Bei Funktionsstörungen oder Beschädigungen schalten Sie sofort die Versorgungsspannung ab und senden das Gerät zur Überprüfung ins Werk.</p>
---	---

Die angegebenen Daten dienen allein der Produktbeschreibung und sind nicht als zugesicherte Eigenschaften im Rechtssinne aufzufassen. Im Zweifelsfall gilt der englische Text

Hinweise für den Betrieb in explosionsgefährdeter Umgebung	<p>ACHTUNG EXPLOSIONSGEFAHR !</p> <p>Geräte die am Leistungsschild mit "Class I Div 2" gekennzeichnet sind, sind für den Einsatz in Klasse I Division 2 Gruppen A,B,C,D oder für explosions-ungefährliche Aufstellorte geeignet. Veränderungen an Bauteilen können die Tauglichkeit für Klasse I Division 2 beeinträchtigen. Anschlüsse nicht trennen solange Spannung anliegt. Anschluss muss unter Berücksichtigung der Anforderungen nach Klasse I Division 2 Artikel 501-4(b) des National Electrical Code, NFPA 70 erfolgen.</p>
--	--

A lire avant mise sous tension !

Français **3**

Merci de lire ces instructions de montage et d'entretien avant de mettre l'alimentation sous tension. Conservez ce manuel qui vous sera toujours utile. Cette alimentation doit être installée par du personnel qualifié et compétent.

Utilisation:
 Cet appareil est conçu pour être installé dans une armoire et pour tous les équipements électroniques, tel que l'équipement industriel de commande, l'équipement de bureau, le matériel de communication et les instruments de mesures. N'utilisez pas cet appareil pour l'équipement de commandes dans les avions, les trains et l'équipement atomique où un problème de fonctionnement de l'alimentation pourrait causer des blessures graves ou menacer la vie humaine.

<p>⚠ ATTENTION !</p> <p>Prendre en compte les points suivants, afin d'éviter toute détérioration électrique, incendie, dommage aux personnes ou mort.</p> <p>(1) ne jamais faire fonctionner l'alimentation sans raccordement à la terre ! (2) débrancher l'installation avant toute intervention sur l'alimentation (ou démontage) et s'assurer qu'il n'y a pas de risque de redémarrage. (3) s'assurer que le câblage a été fait selon les prescriptions (4) ne pas effectuer de réparations ou modifications sur l'alimentation (5) ne pas ouvrir l'appareil. Des tensions importantes passent à l'intérieur. (6) veiller à ce qu'aucun objet ne rentre en contact avec l'intérieur de l'alimentation (trombones, pièces métalliques) (7) ne pas faire fonctionner l'appareil dans un environnement humide ou à l'extérieur, non protégé (8) ne pas utiliser l'appareil dans un environnement où il peut y avoir de la condensation.</p>	<p>⚠ ATTENTION !</p> <p>Des limitations de puissance de sortie peuvent apparaître si :</p> <p>(1) les distances d'installation mini. ne peuvent être observées (2) installation à une altitude > 2000 m (3) pour des fonctionnements en charge et avec une température ambiante > 60°C (4) pour des positions de montage différentes de la préconisation standard (entrée dessous, sortie en haut) (5) lorsque la circulation d'air est gênée</p> <p>D'autres informations sont disponibles dans la documentation de mise en service "</p> <p>Ne pas toucher le carter pendant le fonctionnement ou après la mise sous tension. Surface chaude risquant d'entraîner des blessures.</p> <p>Le déclenchement du fusible interne traduit très probablement un défaut au niveau de l'appareil. Si un défaut quelconque apparaît en cours de fonctionnement, débrancher au plus vite l'alimentation. Dans ce deux cas de figure, il convient de faire contrôler l'alimentation en usine!</p>
---	--

Les données indiquées dans ce document servent uniquement à donner une description du produit et n'ont aucune valeur juridique. En cas de divergences, le texte anglais fait foi.

Utilisation Class I Div 2	<p>ATTENTION RISQUE D'EXPLOSION Les appareils portant la marque "Class I Div 2" au niveau de la plaque signalétique sont prévus pour fonctionner en Classe I, Division 2, Groupes A,B,C,D ou pour un environnement non explosif et non dangereux.</p> <p>Le remplacement de composants peut rendre le matériel impropre à une utilisation en Classe 1, Division 2.</p> <p>Ne déconnecter l'équipement qu' hors tension ou en zone connue comme non dangereuse.</p> <p>Le raccordement doit obligatoirement tenir compte des exigences de la classe 1, division 2, article 501-4(b) du National Electrical Code, NFPA 70.</p>
---------------------------	---

Conserve este manual como referencia para futuras consultas. La fuente de alimentación solo puede ser instalada y puesta en funcionamiento por personal cualificado. Por favor lea detenidamente este manual antes de conectar la fuente de alimentación.

Este equipo ha sido diseñado para su instalación en un ambiente cerrado y ha sido concebido para uso general en instalaciones de control industrial, oficinas, comunicaciones y equipos de instrumentación. No emplee este equipo en aeronaves, trenes e instalaciones atómicas, donde un mal funcionamiento de la fuente de alimentación puede ocasionar lesiones graves o riesgo mortal.

<p>⚠ ADVERTENCIA !</p> <p>Riesgo de descarga eléctrica, incendio, accidente grave o muerte.</p> <ol style="list-style-type: none"> (1) No conectar nunca la unidad sin conexión de puesta a tierra. (2) Desconectar la tensión de red antes de trabajar en la fuente de alimentación. Evite una posible reconexión involuntaria. (3) Asegurarse de que el cableado es correcto de acuerdo a los códigos locales y nacionales. (4) No realizar ninguna modificación o reparación de la unidad. (5) No abrir nunca la unidad. En el interior existe riesgo de altas tensiones. (6) Evitar la introducción en la carcasa de objetos extraños. (7) No usar el equipo en ambientes húmedos. (8) No operar el equipo en ambientes donde se espere la formación de rocío o condensación. 	<p>⚠ CUIDADO !</p> <p>La deriva en la tensión de salida se produce:</p> <ol style="list-style-type: none"> (1) cuando no pueden mantenerse las distancias mínimas de montaje. (2) en caso de que el montaje se realice en altitudes superiores a los 2000 m. (3) en caso de funcionamiento a plena carga y temperaturas ambientales superiores a 60° C. (4) En caso de posiciones de montaje diferentes a la posición de montaje estándar (terminales de entrada abajo y terminales de salida arriba). (5) en caso de que la circulación de aire para la refrigeración por conducción esté obstruida. <p>Puede encontrar más detalles del caso de deriva en este manual.</p> <p>No tocar durante el funcionamiento ni inmediatamente después del apagado. El calor de la superficie puede causar quemaduras graves.</p> <p>Cuando se funde un fusible interno, existe gran probabilidad de un fallo interno en el equipo. Si se produce un fallo o mal funcionamiento durante la operación, desconecte inmediatamente la tensión de alimentación. En ambos casos, el equipo debe ser inspeccionado en fábrica.</p>
--	--

La información presentada en este documento es exacta y fiable en cuanto a la descripción del producto y puede cambiar sin aviso. En casa de duda, prevalece el texto inglés.

Uso apropiado Clase I Div 2	ATENCIÓN PELIGRO DE EXPLOSIÓN! Los equipos marcados con la expresión "Class I Div 2 " son adecuados para su uso en ambientes no peligrosos y en entornos con la Clase I División 2 Grupos A, B, C, D. La sustitución de componentes puede perjudicar la idoneidad para la Clase I División 2. No desconecte el equipo a menos que la tensión de alimentación esté desconectada. El conexionado debe cumplir con la Clase I División 2 métodos de conexión del Código Nacional Eléctrico NFPA 70 o con el resto de códigos locales o nacionales.
--------------------------------	--

Leggere prima questa parte! Italiano **5**

Prima di collegare il sistema di alimentazione elettrica si prega di leggere attentamente le seguenti avvertenze. Conservare le istruzioni per la consultazione futura. Il sistema di alimentazione elettrica deve essere installato solo da personale competente e qualificato.

Questo apparecchio è previsto per il montaggio in un rack per moduli elettronici, ad esempio per controllori industriali, apparecchiature per ufficio, unità di comunicazione o apparecchi di misura. Non utilizzare l'apparecchio in impianti di controllo di aerei, di treni o di impianti nucleari in cui il suo eventuale guasto può comportare gravi lesioni o la morte di persone.

<p>⚠ AVVERTENZA!</p> <p>Il mancato rispetto delle seguenti norme può provocare folgorazione elettrica, incendi, gravi incidenti e perfino la morte.</p> <ol style="list-style-type: none"> (1) Non far funzionare in nessun caso il sistema di alimentazione elettrica senza conduttore di protezione! (2) Prima di eseguire interventi di installazione, di manutenzione o di modifica scollegare la tensione di rete ed adottare tutti i provvedimenti necessari per impedirne il ricollegamento non intenzionale. (3) Assicurare un cablaggio regolare e corretto. (4) Non tentare di modificare o di riparare da soli l'apparecchio. (5) Non aprire l'apparecchio. Al suo interno sono applicate tensioni elettriche pericolose. (6) Impedire la penetrazione di corpi estranei nell'apparecchio, ad esempio fermagli o altri oggetti metallici. (7) Non far funzionare l'apparecchio in un ambiente umido. (8) Non far funzionare l'apparecchio in un ambiente soggetto alla formazione di condensa o di rugiada. 	<p>⚠ CAUTELA !</p> <p>È necessario ridurre la potenza di uscita se:</p> <ol style="list-style-type: none"> (1) non è possibile rispettare le distanze minime di montaggio; (2) l'apparecchio viene installato in un luogo di altitudine maggiore di 2000 m; (3) il funzionamento è a pieno carico a temperatura ambiente maggiore di 60 °C; (4) la posizione di montaggio differisce da quella standard (ingresso in basso, uscita in alto); (5) è ostacolata la libera circolazione dell'aria. <p>Ulteriori informazioni sono riportate in questo manuale.</p> <p>Non toccare quando acceso e subito dopo lo spegnimento. La superficie calda può causare scottature.</p> <p>In caso di intervento del fusibile interno, molto probabilmente l'apparecchio è guasto.</p> <p>Se durante il funzionamento si verificano anomalie o guasti, scollegare immediatamente la tensione di alimentazione.</p> <p>In entrambi i casi è necessario far controllare l'apparecchio dal produttore!</p>
---	--

I dati sono indicati solo a scopo descrittivo del prodotto e non vanno considerati come caratteristiche garantite dell'apparecchio. In caso di differenze o problemi è valido il testo inglese

Uso previsto Class I Div 2	ATTENZIONE: PERICOLO DI ESPLOSIONE! Gli apparecchi la cui targhetta riporta "Class I Div 2 " sono adatti per l'impiego in ambienti di classe I, divisione 2, gruppi A, B, C e D o non soggetti al pericolo di esplosione. La modifica dei componenti possono influenzare negativamente l'idoneità per ambienti di classe I, divisione 2. Non aprire i morsetti con tensione di alimentazione collegata. Il collegamento deve essere eseguito nel rispetto dei requisiti previsti dalla classe I, divisione 2, articolo 501-4(b) del National Electrical Code, NFPA 70.
-------------------------------	---

Leia primeiro! Português **6**

Recomendamos a leitura cuidadosa das seguintes advertências e observações, antes de colocar em funcionamento a fonte de alimentação. Guarde as Instruções para futura consulta, em casos de dúvida. A fonte de alimentação deverá ser instalada apenas por profissionais da área, tecnicamente qualificados.

Utilize apenas para o fim pré-estabelecido. Este aparelho foi concebido para ser montado dentro de invólucros, caixas ou armários para aparelhos eletrônicos em geral, como, por exemplo, comandos de instalações industriais, aparelhos para escritórios, aparelhos de comunicação ou instrumentos de medida e quadros elétricos. Não utilize este aparelho em sistemas de comando de aviões, de comboios ou em instalações movidas por energia nuclear, nos quais um defeito de funcionamento poderá causar danos graves ou significar risco de morte.

<p>⚠ ATENÇÃO !</p> <p>A não observância ou o incumprimento dos pontos a seguir mencionados, poderá causar uma descarga elétrica, incêndios, acidentes graves ou morte.</p> <ol style="list-style-type: none"> (1) Não use a fonte de alimentação sem o condutor de proteção terra! (2) Antes de trabalhos de instalação, manutenção ou modificação, desligue a tensão de alimentação, protegendo-a contra uma nova ligação involuntária. (3) As ligações devem ser efectuadas apenas por profissionais competentes. (4) Não efectue nenhuma modificação ou tentativa de reparação no aparelho. Quando necessário contacte o seu distribuidor. (5) Não abra o aparelho mesmo quando desligado. No seu interior existem condensadores que podem estar carregados electricamente. (6) Proteger a fonte de alimentação contra a introdução inadvertida de corpos metálicos, como por ex., cliques ou outras peças de metal. (7) Não usar o aparelho em ambientes húmidos. (8) Não usar o aparelho em ambientes propensos a condensações. 	<p>⚠ CUIDADO !</p> <p>Será necessário reduzir a potência de saída nos seguintes casos:</p> <ol style="list-style-type: none"> (1) Quando não forem observadas as distâncias mínimas de montagem. (2) Quando instaladas a altitudes superiores a 2000m. (3) Existencia de temperatura ambiente superior a 60°C, em plena carga do aparelho. (4) Montagem invertida do aparelho (Entrada em baixo, saída em cima). (5) Montagem em ambiente sem ventilação. <p>No presente manual de funcionamento encontram-se ainda outras informações.</p> <p>Não tocar enquanto estiver em funcionamento, nem após a desligar. A superfície poderá estar quente e provocar lesões.</p> <p>Se o fusível interno se fundir, é grande a possibilidade de existir um defeito no aparelho. Se por acaso, durante a utilização ocorrer algum defeito de funcionamento ou dano, desligue imediatamente a tensão de alimentação.</p> <p>Em ambos os casos, será necessária uma verificação na Fábrica!</p>
---	--

Os dados mencionados têm como finalidade somente a descrição do produto, e não devem ser interpretados como propriedades garantidas no sentido jurídico. Em caso de dúvidas, aplica-se o texto em Inglês.

Utilize Class I Div 2	ATENÇÃO, RISCO DE EXPLOÇÃO ! Aparelhos que contêm na sua placa de dados elétricos o texto "Class I Div 2 " são apropriados para a aplicação na Classe I, divisão 2, Grupos A, B, C, D ou também para locais de instalação isentos de riscos de explosão. Modificações efetuadas em componentes podem restringir ou reduzir a adequação para aplicação na Classe I, Divisão 2. As ligações não devem ser separadas enquanto estiverem ligadas a uma fonte de alimentação elétrica. As ligações devem ser efetuadas levando-se em consideração as exigências normativas da Classe I, Divisão 2.
--------------------------	---

Technical Data

QS5.241		
Output Voltage	DC 24-28V	externally adjustable
Factory Set	typ. 24.1V	at full rated load
Output Current	min 5-4.5A	continuous
	min 7.5-6.7A	for typ. 4 sec
Output Power	min. 120W	continuous
	min. 180W	for typ. 4 sec
Output Ripple	max. 50mVpp	BW DC to 20MHz
Over-voltage Protection	max. 36Vdc	
AC Input Voltage	- AC 100-240V -15/+10%, 50-60Hz	TN, TT and IT mains
AC Input Current	max. 1.4-0.65A	at 100 - 240Vac
DC Input	- DC 110-300V -20/+20%	
DC Input Current	max. 1.2-0.45A	at 110 - 300Vdc
Power Factor	typ. 0.99-0.91	at 100 - 230Vac
AC Inrush Current	max. 15A peak, 1A ² s	at 100 - 240Vac
Efficiency	typ. 91.6 / 92.7%	at 120 / 230Vac
Losses	typ. 11.0 / 9.4W	at 120 / 230Vac
Hold-up Time	typ. 34 / 65ms	at 120 / 230Vac
Capacitive Loads	- No limitations	
Inductive Loads	- No limitations	
Limited Warranty	- 3 year	

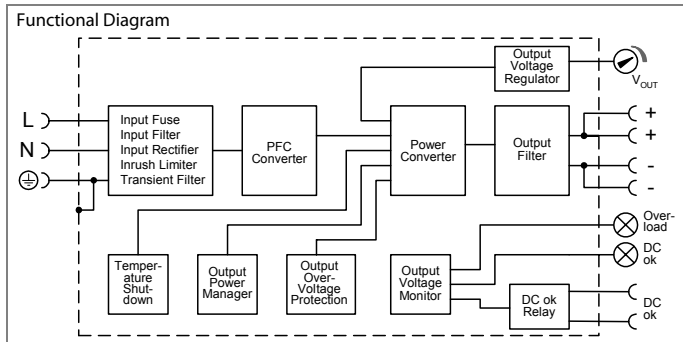

Dielectric Strength

Type tests and factory tests: Conducted by the manufacturer. Do not repeat test in field!
Field test rules:
(1) Use appropriate test equipment which apply the voltage with a slow ramp!
(2) Connect L and N together as well as all output poles.
(3) Use only AC test-voltages with 50/60Hz. The output voltage is floating and has no ohmic reference to ground.

	A	B	C	D	
Type Test	60s	2500Vac	3000Vac	500Vac	500Vac
Factory Test	5s	2500Vac	2500Vac	500Vac	500Vac
Field Test	5s	2000Vac	2000Vac	500Vac	500Vac

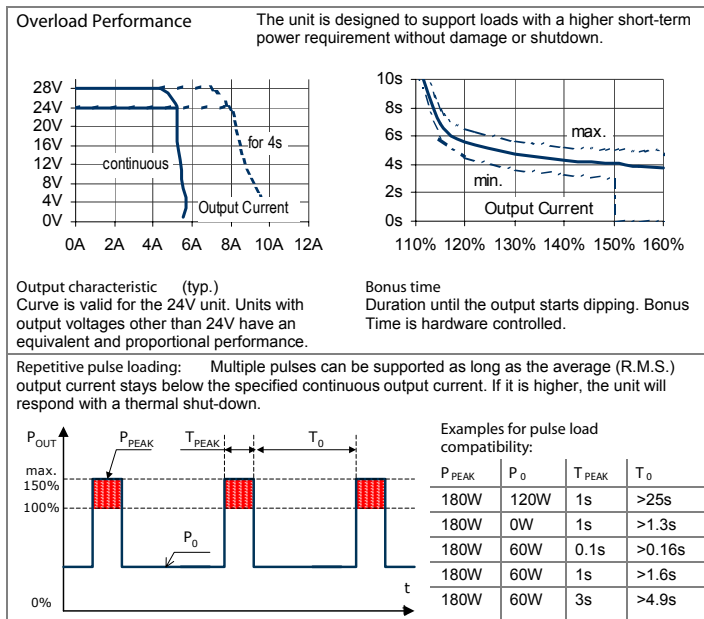
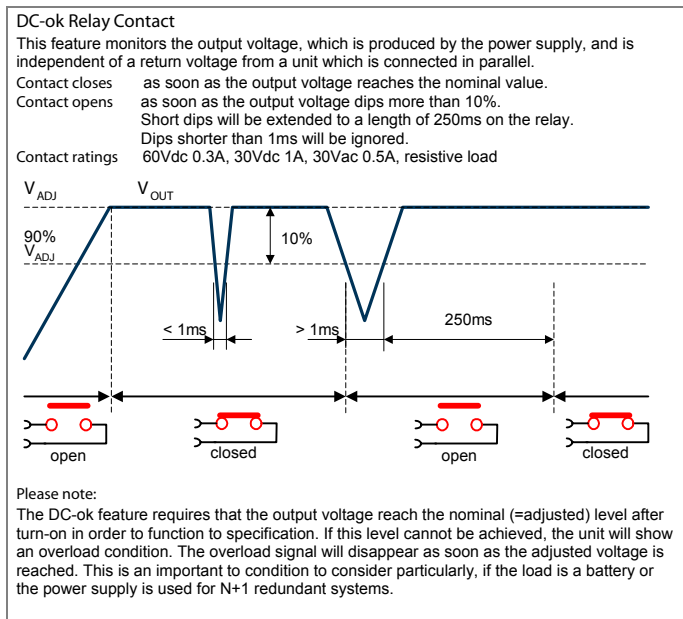

Environment

Operational temperature	-25 to +70°C	De-rate above +60°C
Storage temperature	-40 to +85°C	Storage, transport
Humidity	5 to 95% RH	No condensation allowed
Vibration sinusoidal	2g	IEC 60068-2-6
Shock	30g 6ms, 20g 11ms	IEC 60068-2-27

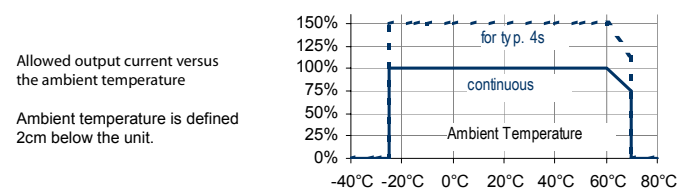

Protection

Output	Overload, no-load, short-circuit proof	
Degree of protection	IP 20	EN/IEC 60529
Class of protection	I	PE (Ground) connection required!
Degree of pollution	2	EN 50178, not conductive
Over-temperature protection	yes	Output shut-down with automatic restart
Output over-voltage protection	yes	Output shut-down with automatic restart
Over-voltage category	III	EN 50178
Penetration protection	>3.5mm	e.g. screws, small parts ...
Internal input fuse	T3.15A	Device protection, not externally accessible
External fuse on input	The unit is tested and approved for branch circuits up to 20A. External protection is only required, if the supplying branch has an ampacity greater than this. In some countries local regulations might apply. Check also local codes and local requirements. If an external fuse is necessary or utilized, a minimum value of B6A or C3A is required to avoid a wrong tripping of the circuit breaker.	

Parallel Operation

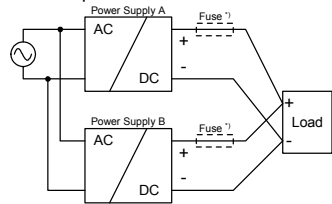

- (1) Use only power supplies from the same Dimension Q-series.
- (2) Adjust the output voltages of all power supplies to approximately the same value ($\pm 50\text{mV}$). Otherwise, the DC-ok signal might not work properly.
- (3) A fuse (or diode) on the output is only required if more than three units are connected in parallel.
- (4) Keep an installation clearance of 15mm (left/right) between two power supplies and avoid installing the power supplies on top of each other.

Serial Operation

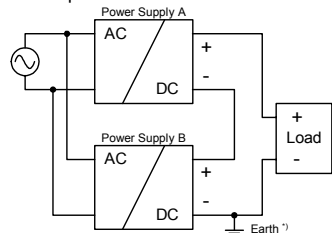

- (1) It is possible to connect as many units in series as needed, providing the sum of the output voltage does not exceed 150Vdc.
- (2) Voltages with a potential above 60Vdc are not SELV any more and can be dangerous. Such voltages must be installed with a protection against touching.
- (3) For serial operation use power supplies of the same type.
- (4) Earthing of the output is required when the sum of the output voltage is above 60Vdc.
- (5) Keep an installation clearance of 15mm (left/right) between two power supplies and avoid installing the power supplies on top of each other.

! Check touch current (earth leakage current)! The total touch current is the sum of the touch currents of all units. Safety limits – depending on the field of application – apply for the allowed touch current!

Operation on Two Phases

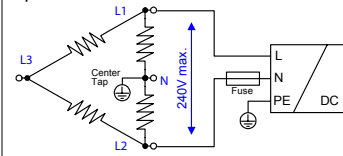

- (1) A phase to phase connection is allowed as long as the supplying voltage is below $240\text{V}^{+10\%}$.
- (2) Use a fuse or a circuit breaker to protect the N input. The N input is internally not protected and is in this case connected to a hot wire.

Operation with DC Input

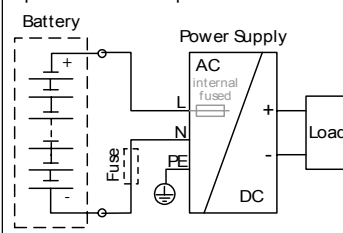

- (1) The power supply will operate with a DC input voltage.
- (2) Use a battery or similar DC source.
- (3) Connect +pole to L and -pole to N
- (4) In case the -pole of the battery is not grounded, use an appropriate fuse to protect the N terminal.
- (5) Connect the ground terminal of the power supply to a PE wire or to machine ground.

EMC

The device is suitable for applications in industrial environment as well as in residential, commercial and light industry environment without any restrictions. For further details see datasheet.

EMC Immunity	EN 61000-6-1, EN 61000-6-2
EMC Emission	EN 61000-3-2, EN 61000-3-3, EN 61000-6-3, EN 61000-6-4, FCC Part 15 Class B

This device complies with FCC Part 15 rules. Operation is subjected to following two conditions: (1) this device may not cause harmful interference, and (2) this device must accept any interference received, including interference that may cause undesired operation.

CE CE mark in conformance with EMC guideline 89/336/EEC and 93/68/EEC and low-voltage directive (LVD) 73/23/EWG.

Safety

Separation of output	SELV	IEC/EN 60950-1
	PELV	EN 60204-1, EN 50178, IEC 60364-4-41
Touch current	max. 0.4mA	Earth leakages current, TN- mains
Isolation resistance	min. 5MOhm	Input to output, 500Vdc
PE resistance	max. 0.1Ohm	Between housing and ground terminal
Transformer	Safety transformer according to IEC/EN 61558-2-17	
Approvals	See datasheet or markings on the unit	

Terminals and Connections

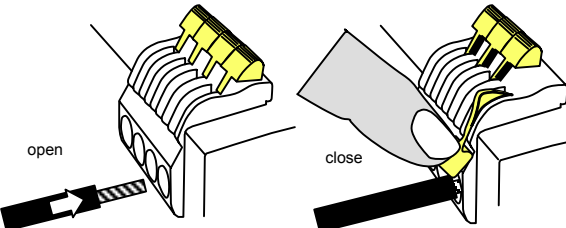

1. Insert the wire
2. Snap the lever

Terminals	Input	Output	DC-ok
Type	Bi-stable, quick-connect spring clamp terminals		
Ferrules	Allowed, but not required		
Solid wire	0.5-6mm ²	0.3-4mm ²	0.3-4mm ²
Stranded wire	0.5-4mm ²	0.3-2.5mm ²	0.3-2.5mm ²
AWG	AWG 20-10	AWG 28-12	AWG 28-12
Stripping length	10mm / 0.4inch	6mm / 0.25inch	6mm / 0.25inch
Pull-out force	10AWG:80N, 12AWG:60N, 14AWG:50N, 16AWG:40N (UL486E)		

! Use appropriate copper cables that are designed for an operating temperatures of 60°C (for ambient up to 45°C) and 75°C (for ambient up to 60°C), minimum. Follow national installation codes and regulations! Ensure that all strands of a stranded wire enter the terminal connection! Up to two stranded wires with the same cross section are permitted in one connection point (except PE wire). Do not use without PE (Ground) connection!

Physical Dimensions, Indicators and Cooling

Width	40mm / 1.57"
Height	124mm / 4.88"
Depth	117mm / 4.61" plus DIN-rail depth
Weight	620g / 1.37lb
DIN-Rail	Use DIN-rails according to EN 60715 or EN 50022 with a height of 7.5 or 15mm
Mounting Orientation	Output terminal on top and input terminals on the bottom. For other orientations see datasheet.

Indicators	DC-ok LED (green)	Overload lamp (red)	DC-ok Relay
Normal operating mode	ON	OFF	Closed
BonusPower [®] operation	ON	OFF	Closed
Overload ($V_{OUT} < 90\%$)	OFF	ON	Open
Short-circuit ($V_{OUT} = 0$)	OFF	ON	Open
Temperature shut-down	OFF	Flashing	Open
No input power	OFF	OFF	Open

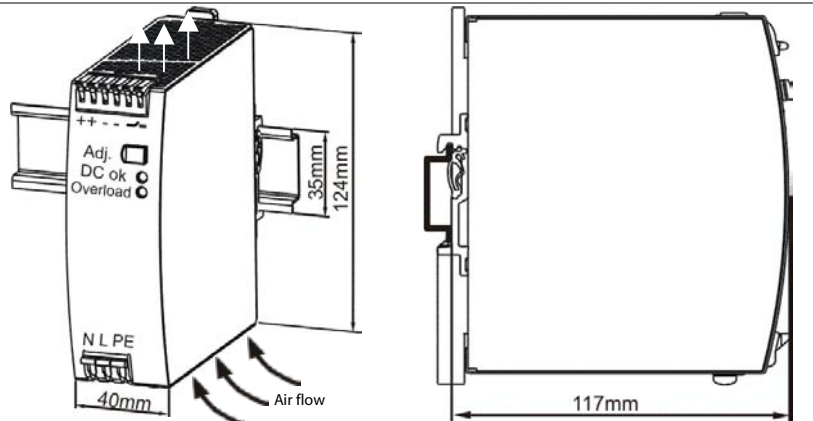

! Do not obstruct air flow! The unit is convection cooled. Ventilation grid must be kept free of any obstructions. Keep installation clearances at higher ambient temperature and full load: 40mm on top, 20mm on the bottom, 5mm on the left and right side are recommended when loaded permanently with full power. In case the adjacent device is a heat source, 15mm clearance are recommended.