

HA930

HA430



General Description

The HA930/430 Series strain gauge input make it ideal for melt pressure control. Featuring high speed sampling and control at 0.025 seconds (40Hz), PID parameters set in 1/100 unit, these controllers provide stable control for improved quality of extruded products.

* Our controllers can be used with other brand of strain gauge sensors. Please contact RKC for more details.

Features

- ☆ Strain gauge input type
- ☆ Ultra High Speed Sampling 0.025 sec
- ☆ 7 inputs and 5 outputs
- ☆ Two Channels in One Controller
- ☆ Communications

Fast sampling of 40 times per second

Provides 0.025 second sampling cycle to measure and control fast changing processes like pressure.

Numerous functions to improve quality

PV transfer function is activated when switching from MAN (manual) to AUTO (automatic) to keep the ideal RPM which is found at Manual Mode.

To protect screws from abrupt change of RPM, HA430/930 provides Manual output transfer function at input abnormality, motor RPM driving output transfer function, forced reset input of Manual value.

7 inputs and 5 outputs

A maximum of two measured inputs and five event inputs can be specified. A maximum of five outputs can be specified, and various output functions (control output, analog retransmission, event up to 4) can be allocated in output logic operation.

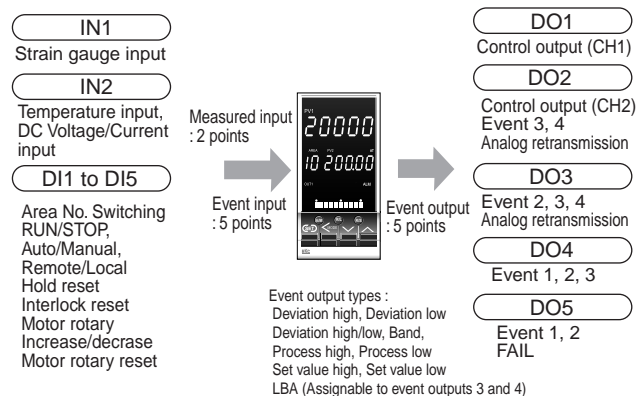

Easy zero and span adjustments

Auto-zero and span adjustments are available from the front panel.

The span adjustment is accomplished by setting the sensor

Temperature and Pressure control with a single instrument

The HA930 and HA430 provide dual loop control with a single instrument. The first loop is assigned to a strain gauge input and the second loop to a temperature input (T/C, RTD, and mV/V/mA).

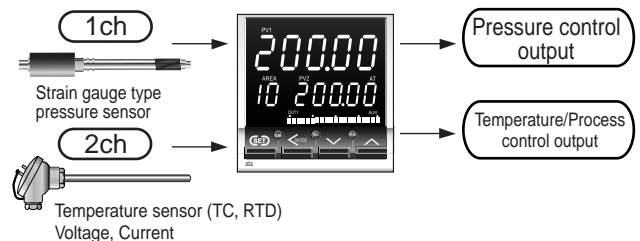

Communications

Communication function can be selected from serial communication (RS-232C, RS-422A, RS-485) and Open network (DeviceNet, PROFIBUS).

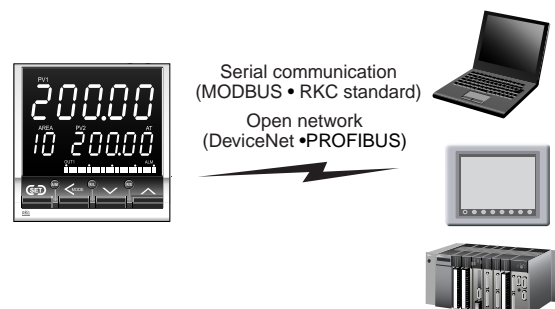

* Optional infrared communication function with a PDA.

Specifications

Input

Number of inputs

- 2 points (IN1 to IN2)
 - Isolated between each channel
 - 2nd input (IN2) can be used as a remote input

Input

- a) Input 1 (IN1) : Strain gauge type pressure sensor
 - Bridge impressed voltage : 8V DC $\pm 3\%$, 80ppm/ $^{\circ}$ C, 30mA(MAX)
- b) Input 2 (IN2) : Temperature input, Voltage/Current input
 - Universal input within group
 - 1) Low voltage input group
 - Thermocouple : K, J, E, T, R, S, B, N (JIS/IEC)
 - PLII (NBS), W5Re/W26Re (ASTM)
 - RTD : Pt100 (JIS/IEC), JPt100 (JIS)
 - 3 wire system
 - Low voltage : 0 to 1V DC, 0 to 100mV DC, 0 to 10mV DC
 - Current : 4 to 20mA DC, 0 to 20mA DC (Input impedance : 50 Ω)
 - 2) High voltage group
 - High voltage : 0 to 5V DC, 1 to 5V DC, 0 to 10V DC

Sampling Time

0.025 sec

Zero point adjustment

-5.0 to +5.0mV (Pressure sensor input)

Gain setting

0.500 to 4.000mV/V (Pressure sensor input)

Input Digital Filter

0.01 to 10.00 sec (OFF when 0 is set.)

PV Bias

-span to +span

PV Ratio

0.500 to 1.500

Square Root Extraction

Equation : $PV = \sqrt{\text{Input value} \times \text{PV ratio} + \text{PV bias}}$
 Low level cut OFF : 0.00 to 25.00% of span

Performance

Measuring Accuracy

- a) Strain gauge type input (Pressure input)
 - $\pm(0.1\%$ of Span)
- b) Thermocouple
 - Type : K, J, T, E, PLII
 - Less than -100° C (-148° F) : $\pm 1.0^{\circ}$ C ($\pm 1.8^{\circ}$ F)
 - -100 to 500° C (-148 to 932° F) : $\pm 0.5^{\circ}$ C ($\pm 0.9^{\circ}$ F)
 - More than 500° C (932° F) : $\pm(0.1\%$ of Reading + 1 digit)
 - Type : N, S, R, W5Re/W26Re
 - Less than -100° C (-148° F) : $\pm 2.0^{\circ}$ C ($\pm 3.6^{\circ}$ F)
 - -100 to 1000° C (-148 to 1832° F) : $\pm 1.0^{\circ}$ C ($\pm 1.8^{\circ}$ F)
 - More than 1000° C (1832° F) : $\pm(0.1\%$ of Reading + 1 digit)
 - Type : B
 - Less than 400° C (752° F) : $\pm 70.0^{\circ}$ C ($\pm 126^{\circ}$ F)
 - 400 to 1000° C (752 to 1832° F) : 1.0° C (1.8° F)
 - More than 1000° C (1832° F) : $\pm(0.1\%$ of Reading + 1 digit)
- Col junction temperature compensation error
 - $\pm 1.0^{\circ}$ C (1.8° F) [at 23° C $\pm 2^{\circ}$ C (73.4° F $\pm 3.6^{\circ}$ F)]
 - Within $\pm 1.5^{\circ}$ C ($\pm 2.7^{\circ}$ F) [Between 0 and 50° C (14 to 122° F)]
- c) RTD
 - Less than 200° C (392° F) : $\pm 0.2^{\circ}$ C ($\pm 0.4^{\circ}$ F)
 - More than 200° C (392° F) : $\pm(0.1\%$ of Reading + 1 digit)
- d) DC voltage and DC current
 - $\pm(0.1\%$ of span)

Insulation Resistance

More than 20M Ω (500V DC) between measured terminals and ground
 More than 20M Ω (500V DC) between power terminals and ground

Dielectric Strength

1000V AC for one minute between measured terminals and ground
 1500V AC for one minute between power terminals and ground

Control

Control Method

Brilliant PID control with enhanced autotuning.
 • Available for reverse and direct action.

Control Method

Brilliant PID control with enhanced autotuning.
 • Available for reverse and direct action.

Major Setting Range

Set value : Same as input range.
 Proportional band : 0 to input span (Temperature input)
 0.0 to 1000.0% of span (Voltage, Current input)
 Integral time : 0.00 to 360.00sec. or 0.0 to 3600.0sec.
 (selectable)
 Derivative time : 0.00 to 360.00sec. or 0.0 to 3600.0sec.
 (selectable)
 Control response : Slow, Medium, Fast
 Output limiter : -5.0 to +105.0% (High/Low individual setting)
 Output change rate limiter : 0.0 to 100.0%/sec. (Up/Down individual setting)
 Proportional cycle time : 0.1 to 100.0 sec.
 Memory area : 16 sets

Other functions

PV transfer function
 This is a function to set the PV to the SV when the operation mode has been changed from a Manual to an Auto mode to suppress rapid change in output.
 Manual output transfer function at input abnormality
 When the input exceeds the input abnormality decision point, the output reached at that time is maintained.
 MV transfer function
 In this function, an output value is stored when the operation mode is changed from MAN to AUTO mode, and when the mode changes from AUTO to MAN via digital input, the stored output value is retrieved.

Output

Main Output

Number of output : Up to 3 points (OUT1 to OUT3)
 Output function : OUT1, 2 : Control output
 OUT3 : Event output or analog retransmission output (Optional)
 Output type : Relay output :
 Form A contact, 250V AC 3A (resistive load)
 Voltage pulse output : 0/12V DC
 (Load resistance : More than 600 Ω)
 Current output : 4 to 20mA DC, 0 to 20mA DC
 (Load resistance : Less than 600 Ω)
 Continuous voltage output :
 0 to 5V DC, 1 to 5V DC, 0 to 10V DC
 (Load resistance : More than 1k Ω)
 SSR (Triac) output (Rated current : 0.4A)

Sub Output (Optional)

Number of output : Up to 2 points (OUT4, OUT5)
 Output function : Event output (Optional)
 Output type : Relay output :
 Form A contact, 250V AC 1A (resistive load)

Sensor Power Supply Output (Optional)

24V DC $\pm 5\%$ (Max.24mA)
 • Output from OUT3.
 • When sensor power supply output is specified, OUT4 and OUT5 can not be added.

Event (Alarm) Output (Optional)

Number of Event Outputs

Up to 4 points (Event 1 to 4)

Alarms

Type : Deviation High, Low, High/Low, Band,
 Process High, Low
 Set value High, Low
 Differential gap : 0 to input span

Control Loop Break Alarm (LBA)

LBA time setting : 0.1 to 7200 sec. (OFF by setting zero)
 LBA deadband : 0 to input span

Output

Assignable to main output (OUT3) or sub output (OUT4 to 5).

Other Functions

HOLD action (Valid for deviation/band/PV alarms only)
 Selection of event action for input abnormality.

Specifications

Non-isolated Remote Setpoint Input (Optional)

Input

- a) 0 to 1V DC, 0 to 100mV DC, 0 to 10mV DC
- b) 0 to 5V DC, 1 to 5V DC, 0 to 10V DC
- c) 4 to 20mA DC, 0 to 20mA DC

Accuracy

0.1% of span

* Only available in a 1 channel control type.

Event Input (Optional)

Number of Inputs

Up to 7 points

Input Rating

Non-voltage contact input

Functions

- a) Memory area selection
- b) Run/Stop switching
- c) Remote/Local switching
- d) Auto/Manual switching

• Event input logic selection functional allocation table

	DI1	DI2	DI3	DI4	DI5
A	Memory area selection (1 to 16)				Area set
B	Memory area selection (1 to 8)			Area set	Run/Stop
C	Memory area selection (1 to 8)			Area set	Remote/Local
D	Memory area selection (1 to 8)			Area set	Remote/Local
E	Memory area selection (1 to 8)			Area set	Peak/Bottom hold reset
F	Memory area selection (1 to 8)			Area set	Interlock release
G	Memory area selection (1 to 4)		Area set	Run/Stop	Auto/Manual
H	Memory area selection (1 to 4)		Area set	Run/Stop	Remote/Local
I	Memory area selection (1 to 4)		Area set	Remote/Local	Auto/Manual
J	Memory area selection (1 to 4)		Area set	Peak/Bottom hold reset	Interlock release
K	Auto/Manual	Run/Stop	Remote/Local	Peak/Bottom hold reset	Interlock release
L	Auto/Manual	CH1 manual output down	CH1 manual output up	CH1 manual output 0% reset	Run/Stop
M	Auto/Manual	CH2 manual output down	CH2 manual output up	CH2 manual output 0% reset	Run/Stop

Analog Retransmission Output (Optional)

Number of Outputs

Up to 3 points

- Functions are assignable to OUT1 to OUT3.

Output types

- a) Measured value (PV)
- b) Deviation (DV)
- c) Set value (SV)
- d) Manipulated output value (MV)

Communications (Optional)

Number of communications : 2 points

Communication method : COM1: RS-485, RS-232C
COM2: RS-232C, RS-485, RS-422A
DeviceNet, PROFIBUS

Communication speed : 2400, 9600, 19200, 38400 BPS

Protocol : ANSI X3.28(1976) 2.5 A4
MODBUS

Bit format

Start bit : 1
Data bit : 7 or 8 •For MODBUS 8 bit only
Parity bit : Without, Odd or Even
Stop bit : 1 or 2

Communication code : ASCII(JIS) 7-bit code

Maximum connection :

RS-485, RS-422A : 31
(Address can be set from 0 to 99.)
RS-232C : 1

Infrared Port Communication

Infrared Port :

IrDA standard

Software Name :

RKC IR for HA Series

Support OS :

Windows Pocket PC 2002

- This software is downloadable from RKC's website at : www.rkcinst.com.

Waterproof/Dustproof

Waterproof/dustproof protection : IP65

- Waterproof/dustproof protection only effective from the front in panel mounted installations.

General Specifications

Supply Voltage

- a) 90 to 264V AC (Including supply voltage variation)
[Rating : 100 to 240V AC] (50/60Hz common)
- b) 21.6 to 26.4V AC (Including supply voltage variation)
[Rating : 24V AC] (50/60Hz common)
- c) 21.6 to 26.4V DC (Ripple rate 10% p-p or less) [Rating:24VDC]

Power Consumption

- HA430 : Less than 22.5VA for AC type (at 240V AC)
Less than 15.0VA for 24V AC type
Less than 430mA for 24V DC type
- HA930 : Less than 24.0VA for AC type (at 240V AC)
Less than 16.0VA for 24V AC type
Less than 470mA for 24V DC type

Power Failure Effect

Not affected by power failure shorter than 20msec, otherwise reset to the initial state. (HOT or COLD start is selectable.)

Self-Diagnostic Function

CPU power check, Adjustment data check, EEPROM check, RAM check, etc..

Operating Environments

- 10 to 50°C [14 to 122°F]
- 5 to 95% RH.(No condensing)
- Absolute sensitivity : Max. W.C 29g/m³ dry air at 101.3kPa

Memory Backup : Backed up by non-volatile memory.

Number of writing : Approx. 100,000 times

Net Weight

- HA430 : Approx. 360g
- HA930 : Approx. 460g

External Dimensions (W x H x D)

- HA430 : 48 x 96 x 100mm
- HA930 : 96 x 96 x 100mm

Compliance with Standards

- CE Mark
- UL Recognized
- CSA Certified
- C-Tick Mark



• Event output logic selection functional allocation table

	OUT1	OUT2	OUT3	OUT4	OUT5
A	CH1 control output	Event 3,4 (Energized)	Event 2 (Energized)	Event 1 (Energized)	FAIL (De-energized)
B	CH1 control output	Event 3, 4 (De-energized)	Event 2 (De-energized)	Event 1 (De-energized)	FAIL (De-energized)
C	CH1 control output	CH2 control output	Event 4 (Energized)	Event 3 (Energized)	Event 1,2 (Energized)
D	CH1 control output	CH2 control output	Event 4 (De-energized)	Event 3 (De-energized)	Event 1, 2 (De-energized)
E	CH1 control output	CH2 control output	Event 3,4 (Energized)	Event 2 (Energized)	Event 1 (Energized)
F	CH1 control output	CH2 control output	Event 3, 4 (De-energized)	Event 2 (De-energized)	Event 1 (De-energized)
G	CH1 control output	Event 4 (Energized)	Event 3 (Energized)	Event 2 (Energized)	Event 1 (Energized)

* An output logic becomes OR output when two or more output functions are assigned to one output.

* When three analog outputs are selected, the analog outputs are automatically assigned to OUT1 through OUT3 and it has priority over the output logic selection.

Resin Pressure Digital Controller HA930/430

Model and Suffix Code

1 channel control type

Specifications	Model and Suffix Code										
Model	HA430 (48 x 96mm 1/8 DIN size) HA930 (96 x 96mm 1/4 DIN size)		-	<input type="checkbox"/>	<input type="checkbox"/>	<input type="checkbox"/>	<input type="checkbox"/>	<input type="checkbox"/>	<input type="checkbox"/>	<input type="checkbox"/>	<input type="checkbox"/>
Strain gauge type pressure sensor input	CZ-100P/200P input CZ-GP100 input or 0.500 to 4.000mV/V output type pressure sensor (Maximum supply voltage : More than 8V DC)	H X									
Non isolated type remote set value	Not supplied See Remote input code table	0 <input type="checkbox"/>									
Output 1 (Main output)	See output code table	<input type="checkbox"/>									
Output 2 (Main output) * Not isolated from OUT1.	No output from OUT2 See output code table	N <input type="checkbox"/>									
Power supply	24V AC/DC 100 to 240V AC	3 4									
Output 3 (Main output)	No output from OUT3 See output code table	N <input type="checkbox"/>									
Output 4, 5 (OUT4, 5 : Sub output)	No outputs from OUT4 and OUT5 OUT4 : Relay contact output, No output from OUT5 OUT4 and OUT5 : Relay contact output	N 1 2									
Event input 1 to 5	Not supplied Event input : 5 points (DI 1 to DI5)	N 1									
Communication	Not supplied RS-232C (ANSI/RKC standard) RS-422A (ANSI/RKC standard) RS-485 (ANSI/RKC standard) RS-485 (MODBUS) RS-422A (MODBUS) RS-232C (MODBUS) DeviceNet PROFIBUS	N 1 4 5 6 7 8 A B									
Body color	White Black	N A									
Instrument version	Version symbol										Y

<Remarks>

- OUT 1 can be used for control outputs.
- Event (alarm) outputs are assignable to OUT 2 - OUT 5.
- Analog output (PV, SV, etc) are assignable to OUT 1 -OUT 3.
- If two isolated analog outputs are required, use OUT 1 (or OUT 2) and OUT 3.

Remote Signal Code Table

Not isolated from the No.1 input [IN1]

Input type	Code
Low voltage group	0 - 10mV DC
	0 - 100mV DC
	0 - 1V DC
High voltage group	0 - 5V DC
	0 - 10V DC
	1 - 5V DC
Current group	0 - 20mA DC
	4 - 20mA DC

- Configurable within group

Output Code Table

Output Type	Code
Relay contact output	M
Voltage pulse output DC0/12V	V
Continuous voltage output DC 0 to 5V	4
Continuous voltage output DC 0 to 10V	5
Continuous voltage output DC 1 to 5V	6
Current output DC 0 to 20mA	7
Current output DC 4 to 20mA	8
SSR (Triac) output	T



Model and Suffix Code

2 channel control type

Specifications	Model and Suffix Code										
Model	HA430 (48 x 96mm 1/8 DIN size) HA930 (96 x 96mm 1/4 DIN size)					- <input type="checkbox"/> <input type="checkbox"/> - <input type="checkbox"/> <input type="checkbox"/> - <input type="checkbox"/> * <input type="checkbox"/> <input type="checkbox"/> - <input type="checkbox"/> <input type="checkbox"/> - <input type="checkbox"/> <input type="checkbox"/> / <input type="checkbox"/> <input type="checkbox"/>					
Strain gauge type pressure sensor input	CZ-100P/200P input CZ-GP100 input or 0.500 to 4.000mV/V output type pressure sensor (Maximum supply voltage : More than 8V DC)					H					
Input 2 (IN2 : No 2 input)	See Input and Range code table					<input type="checkbox"/>					
Output 1 (Main output)	See output code table					<input type="checkbox"/>					
Output 2 (Main output) * Not isolated from OUT1.	No output from OUT2 See output code table						N	<input type="checkbox"/>			
Power supply	24V AC/DC 100 to 240V AC								3	4	
Output 3 (Main output)	No output from OUT3 See output code table Sensor power supply output *1									N	P
Output 4, 5 (OUT4, 5 : Sub output) *1	No outputs from OUT4 and OUT5 OUT4 : Relay contact output, No output from OUT5 OUT4 and OUT5 : Relay contact output									N	1 2
Event input 1 to 5	Not supplied Event input : 5 points (DI 1 to DI5)									N	1
Communication	Not supplied RS-232C (ANSI/RKC standard) RS-422A (ANSI/RKC standard) RS-485 (ANSI/RKC standard) RS-485 (MODBUS) RS-422A (MODBUS) RS-232C (MODBUS) DeviceNet PROFIBUS										N 1 4 5 6 7 8 A B
Body color	White Black										N A
Instrument version	Version symbol										Y

*1 When sensor power supply output is specified, output 4 and 5 can not added.

<Remarks>

- OUT 1 and OUT 2 can be used for control outputs.
- Event (alarm) outputs are assignable to OUT 2 - OUT 5.
- Analog output (PV, SV, etc) are assignable to OUT 1 - OUT3.
- If two isolated analog outputs are required, use OUT 1 (or OUT 2) and OUT3.

Range and Input Table

Thermocouple, RTD, Low voltage and Current group

Input	Code	Range		Resolution	
K	K	-200 - 1372°C	-328 - 2501°F	1°C, 0.1°C, 1°F, 0.1°F (Selectable)	
J	J	-200 - 1200°C	-328 - 2192°F		
T	T	-200 - 400°C	-328 - 752°F		
E	E	-200 - 1000°C	-328 - 1832°F		
PLII	A	0 - 1390°C	32 - 2534°F		
N	N	0 - 1300°C	32 - 2372°F		
S	S	-50 - 1768°C	-58 - 3214°F		
R	R	-50 - 1768°C	-58 - 3214°F		
W5Re/W26Re	W	0 - 2300°C	32 - 4172°F		
B	B	0 - 1800°C	32 - 3272°F		
Pt100 (3 wire)	D	-200 - 850°C	-328 - 1562°F		1°C, 0.1°C, 0.01°C
JPt100 (3 wire)		-200 - 600°C	-328 - 1112°F		1°F, 0.1°F, 0.01°F (Selectable)
0 - 10mV DC	3	-19999 - 99999 (Programmable)			1, 0.1, 0.01, 0.001, 0.0001 (Programmable)
0 - 100mV DC					
0 - 1V DC					
0 - 20mA DC					
4 - 20mA DC	8				

High voltage group

0 - 5V DC	6	-19999 - 99999 (Programmable)		1, 0.1, 0.01, 0.001, 0.0001 (Programmable)
0 - 10V DC				
1 - 5V DC				

Output Code Table

Output Type	Code
Relay contact output	M
Voltage pulse output DC0/12V	V
Continuous voltage output DC 0 to 5V	4
Continuous voltage output DC 0 to 10V	5
Continuous voltage output DC 1 to 5V	6
Current output DC 0 to 20mA	7
Current output DC 4 to 20mA	8
SSR (Triac) output	T

Resin Pressure Digital Controller HA430/930



External Dimensions and Rear Terminals

Unit : mm

HA930

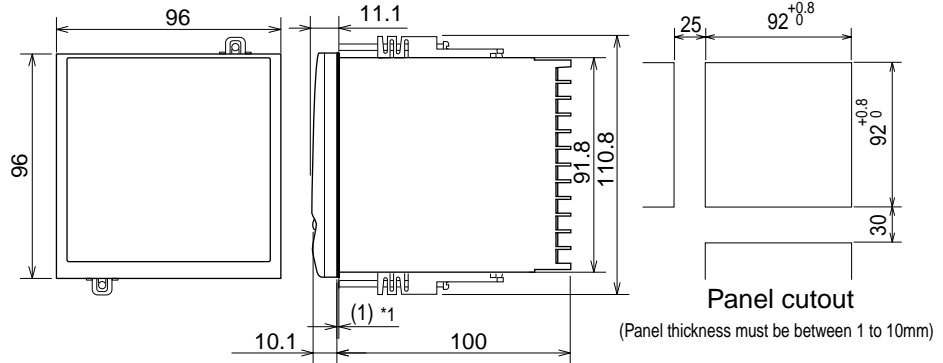
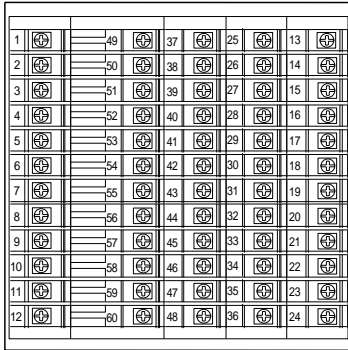

*1 IP65 waterproof/dustproof protection is molded into case and can not be added in the field.

HA430

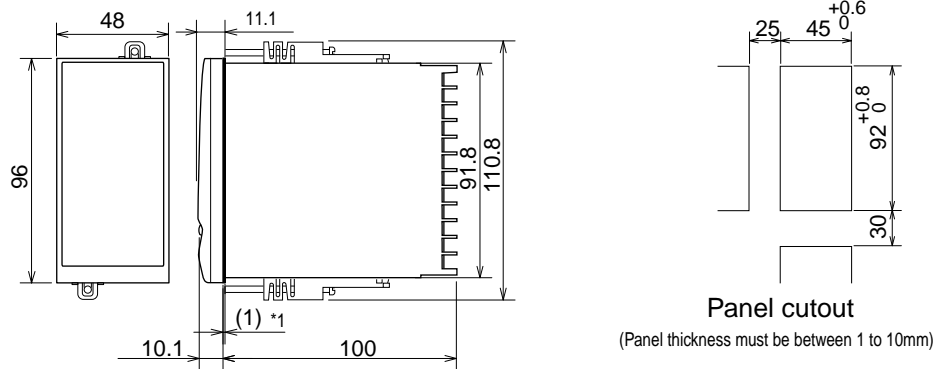
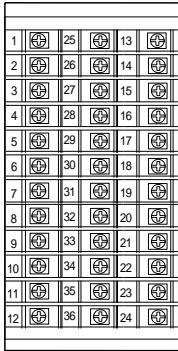

*1 IP65 waterproof/dustproof protection is molded into case and can not be added in the field.

No	Description	No	Description	No	Description
1	100 - 240V AC 24V AC	25	SG	13	No used
2	24V DC	26	T(A)	14	CAL+ Calibration input +
3	Relay contact output	27	T(B)	15	CAL- Calibration input -
4	Relay contact output	28	R(A)	16	SHD Shield
5	Relay contact output	29	R(B)	17	EXC+ Sensor supply voltage +
6	Relay contact output	30	COM (-)	18	EXC- Sensor supply voltage -
7	(1) Relay contact output (2) Voltage pulse/Current/Voltage output (3) SSR (Triac) output (4) Sensor power supply output	31	DI1	19	Non isolated type remote input (A)
8	(1) Relay contact output (2) Voltage pulse/Current/Voltage output (3) SSR (Triac) output	32	DI2 Non-voltage contact input	20	No.2 Input (IN 1) (B)
9	(1) Relay contact output (2) Voltage pulse/Current/Voltage output (3) SSR (Triac) output	33	DI3	21	No used
10	(1) Relay contact output (2) Voltage pulse/Current/Voltage output (3) SSR (Triac) output	34	DI4	22	No used
11	(1) Relay contact output (2) Voltage pulse/Current/Voltage output (3) SSR (Triac) output	35	COM (-)	23	-SIG+ Sensor signal input +
12	(1) Relay contact output (2) Voltage pulse/Current/Voltage output (3) SSR (Triac) output	36	DI5 Non-voltage contact input	24	-SIG- Sensor signal input -
					(A) 1 channel type Non-isolated type remote input (B) 2 channel type Temperature Voltage/Current input (1) Thermocouple (2) RTD (3 wire) (3) Voltage/Current