

# Ramp/Soak temperature controller REX-P300

## REX-P300



### General Description

The REX-P300 is a high performance ramp/soak controller with accuracy of  $\pm 0.1\%$  and 0.1 second sampling cycle time while retaining easy-to-use operation.

The REX-P300 has many standard functions to offer solutions for ramp/soak processing applications such as up to 256 segments, two (2) alarms, four (4) or eight (8) time signal outputs, digital inputs for reset, run and hold mode change and universal input.

REX-P300 also has standard features to make it suited for wide range of applications, such as three types of control mode, and four types of PV start. Control modes can be easily changed among ramp/soak control mode, fixed setpoint control mode and manual mode on REX-P300. Four types of PV start are selectable.

Digital communication, retransmission, and up to three (3) additional alarm/status outputs are available as option.

### Features

- ☆ Four sets of PID parameters
- ☆ Up to 256 segments (maximum 16 patterns)
- ☆ Universal input
- ☆ Time signal outputs, digital inputs, alarms
- ☆ Heat/cool control
- ☆ Position proportional control
- ☆ Ramp/soak, Fixed, Manual control mode
- ☆ PV start selection
- ☆ Three auxiliary alarm/status outputs
- ☆ Digital communications

#### Four sets of PID parameters

Up to four sets of PID parameters can be stored. The temperature range for each PID group is programmable.

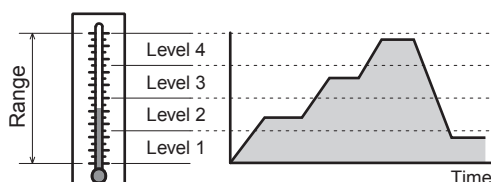

#### 5-digit display

5-digit display enables REX-P300 to display any temperature measured by thermocouple and RTD with the resolution of 0.1°C. Scaling and decimal point for current/voltage input are programmable.

12345

#### Time signal output

On Time and Off Time can be set for each time signal output setting so that time signal output can be used for auxiliary heater/cooler control and input signals to PLCs. Up to 16 settings per pattern are available.

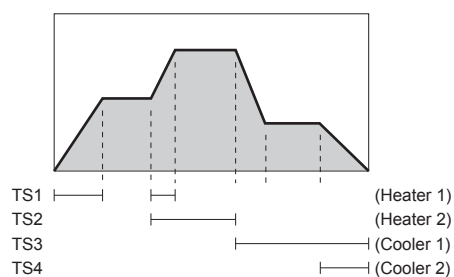

#### Digital input

Control status can be changed among Reset, Run, Step, Hold by digital inputs. Pattern number also can be set by optional digital inputs.

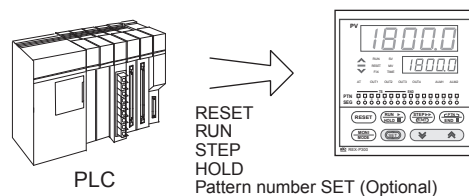

#### Three control modes

REX-P300 has three control modes as standard.

1. Ramp/soak control mode
2. Fixed setpoint control mode
3. Manual control mode

# Ramp/Soak temperature controller REX-P300

## Features

### 16 segments • 16 patterns

Maximum of 16 segments per pattern can be memorized, and maximum 16 patterns can be memorized. Each pattern can be linked together (Pattern link function) so that a program containing up to 256 segments is possible.

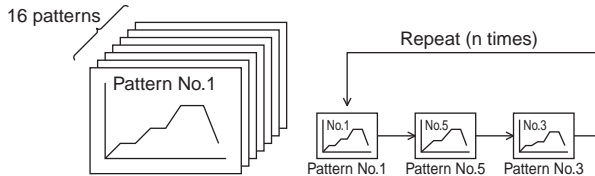

### 2 alarms, Up to 3 additional alarm/status outputs

Two alarms are standard feature of REX-P300. Up to three Auxiliary outputs are possible as option. These outputs can be used for additional alarm/status outputs.

#### Alarm output

- Process high alarm
- Process low alarm
- Deviation high alarm
- Deviation low alarm
- Deviation high/low alarm
- Band alarm
- Set value high alarm
- Set value low alarm
- Fail

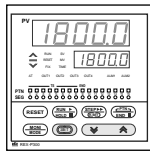

#### Auxiliary output

- Process high alarm
- Process low alarm
- Set value high alarm
- Set value low alarm
- Pattern end status signal
- Soak status signal
- Hold status signal
- Run status signal

### Analog output (Optional)

Analog output is available for recorder or data - logging equipment, etc. Either of the process value (PV), set value (SV), manipulation value (MV), deviation value (DEV) or segment value (TIME) can be output as DC voltage or current.



Analog output

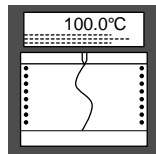

### Heat/cool control (Optional)

The heat/cool PID controller has heat and cool outputs for use where process-generated heat exists. The controller allows the input of overlap or dead band settings which can contribute to energy savings.

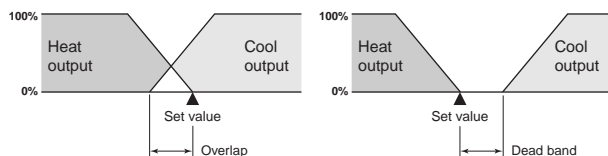

### Digital communications (Optional)

The REX-P300 offers an optional communications interface (RS-232C, RS-422A or RS-485) for networking to computers, PLCs and SCADA software in your plant. Up to 31 units can be interfaced on one RS-422A, RS-485 communication line.

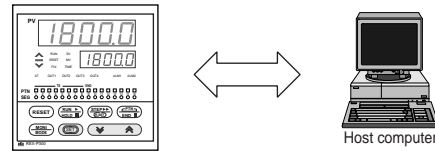

### PV start

There are four start types available on REX-P300.

When ramp/soak control is started:

PV start 1: Time of segment 1 is not changed whatever the PV is.

PV start 2: Time of segment 1 will be shortened to keep the slope of segment 1.

PV start 3: REX-P300 will search the first same value on the program as the PV, and control status will be Hold.

PV start 4: REX-P300 will search the first same value on the program as the PV, and control status will be Run.

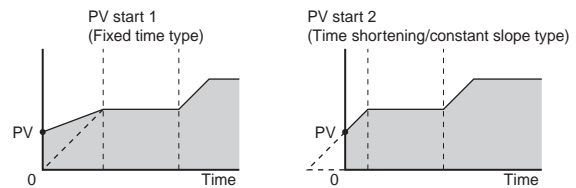

### Driving control motor without feedback resistance

The REX-P300 can drive a control motor without feedback resistance utilizing the new algorithm for position proportional control.

It simplifies wiring and eliminates bothersome care for feedback resistance.

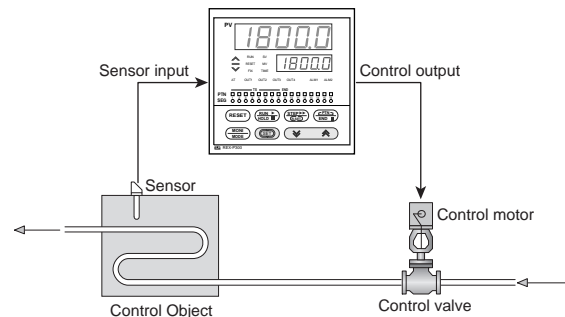

# Ramp/Soak temperature controller REX-P300

## Specifications

### Input

#### Input (Universal input)

- a) Thermocouple : K, J, R, S, B, E, T, N (JIS/IEC), PLII (NBS)  
W5Re/W26Re (ASTM), U, L (DIN)  
Pt40%Rh-Pt20%Rh
- Influence of external resistance : Approx.  $0.4\mu\text{V}/\Omega$
  - Input break action : Up scale or Down scale (selectable)
- b) RTD : Pt100 (JIS/IEC), JPt100 (JIS)
- Influence of input lead resistance : Approx. Less than  $10\Omega$
  - Input break action : Up scale
- c) DC low voltage input group  
0 to 10mV, 0 to 100mV, 0 to 1V, 0 to 5V, 1 to 5V, -100 to 100mV,  
-1 to 1V, -5 to 5V
- Input break action : Down scale
- d) DC high voltage input group : 0 to 10V, -10 to 10V
- Input break action : Uncertain (indicate a value around 0V)
- e) DC current input : 0 to 20mA, 4 to 20mA
- Input break action : Down-scale

Sampling time  
0.1 sec

#### PV bias

Temperature input : -10.0 to 10.0°C [°F]  
DC voltage, DC current : -10.0 to 10.0% of span

#### PV ratio

0.001 to 9.999

### Performance

#### Measuring accuracy

- a) Thermocouple  
( $\pm 0.1\%$  of reading or  $\pm 1^\circ\text{C}$  [°F] whichever is larger)  $\pm 1$  digit  
Cold junction temperature error  
Within  $\pm 0.5^\circ\text{C}$  (between 0 and  $50^\circ\text{C}$  [32 and  $122^\circ\text{F}$ ])
- Accuracy is not guaranteed between 0 and  $400^\circ\text{C}$  (0 and  $752^\circ\text{F}$ ) for type B and type Pt40%Rh-Pt20%Rh input and below  $32^\circ\text{F}$  for type N, PLII, W5Re/W26Re.
- b) RTD  
( $\pm 0.1\%$  of reading or  $\pm 0.5^\circ\text{C}$  [°F] whichever is larger)  $\pm 1$  digit
- Accuracy is not guaranteed between 500 and  $600^\circ\text{C}$  ( $932$  and  $1100^\circ\text{F}$ ).
- c) DC voltage, DC current  
( $\pm 0.1\%$  of span)  $\pm 1$  digit

#### Segment time accuracy

Within  $\pm(0.01\%$  of displayed value)

#### Insulation resistance

More than  $20\text{M}\Omega$  (500V DC) between measured terminals and ground  
More than  $20\text{M}\Omega$  (500V DC) between power terminals and ground

#### Dielectric strength

1000V AC for one minute between measured terminals and ground  
1500V AC for one minute between power terminals and ground

### Program

Storage Program Pattern : Max. 16 patterns (16 segments per pattern)

Storage Segments : Max. 256 segments  
(Possible to link, 16 segments x 16 patterns)

Program Repeat : 1 to 1000 times or continuous.

Level Setting : See input range

Time Setting : 00 hr 00 min to 99 hr. 59 min,  
or 00 min 00 sec to 99 min 59 sec

Start Mode : Zero start or PV start (selectable)

Wait zone : -10.0 to 10.0°C (°F)  
•Individual setting up and down side

### Control

#### Control method

- a) PID control (with autotuning function)  
b) Heat/cool PID control (with autotuning function)  
c) Position proportioning action without feedback resistance

Memory area (PID constant section, etc..) : 4 areas (Level PID method)

#### Major setting range

Set value : Same as input range.  
Heat side proportional band : 0.1 to range span (°C/°F) (Temperature)  
0.1 to 1000.0% of span (Voltage/Current)  
(ON/OFF action when P=0)  
Cool side proportional band : 1 to 3000% of heat side proportional band  
Integral time : 1 to 3600sec.(P + D action when I=0)  
Derivative time : 1 to 3600sec.(P + I action when D=0)  
Proportional cycle : 1 to 100sec.  
Output limiter high : -5.0 to +105.0%  
Output limiter low : -5.0 to +105.0%  
Manual control : -5.0 to +105.0%  
Anti-reset windup : 1 to 100% of proportional band  
Deadband/Overlap : -10.0 to +10.0°C (°F) (Temperature)  
-10.0 to +10.0% of span (Voltage/Current)

#### Control output

Relay output : 250V AC 3A (resistive load), Form C contact  
•Cool side : 250V AC 0.5A (resistive load), Form A contact  
Voltage pulse output : 0/12V DC  
(Load resistance : more than  $800\Omega$ )  
Current output : 0 to 20mA or 4 to 20mA DC  
(Load resistance : less than  $600\Omega$ )  
Continuous voltage output : 0 to 5V, 0 to 10V, 1 to 5V DC  
(Load resistance : more than  $1\text{k}\Omega$ )

### Standard function

#### Time signal

Setting time : 00 hr 00 min to 99 hr. 59 min,  
or 00 min 00 sec to 99 min 59 sec  
Storage pattern : 16 patterns (16 times ON/OFF per pattern)  
Output : 4 or 8 points, open collector output, 24V DC 50mA  
•8 points type is optional.

#### Pattern End Output

Setting time : 00 min 00 sec to 99 min 59 sec  
Output : 1 point, open collector output, 24V DC 50mA

#### External Control

RESET, RUN, HOLD, STEP

### Alarm

#### Temperature alarm

- a) Number of alarm : 2 points  
b) Alarm action : Programmable (Process, Deviation, SV, FAIL)  
c) Alarm delay : 0 to 600 sec.  
d) Alarm differential gap : 0.0 to 10.0°C [°F] (Temperature)  
0.0 to 10.0% of span (Voltage/Current)
- \* Energized/de-energized alarm (Selectable but FAIL alarm is only de-energized alarm)

#### Alarm output

Relay output, 250V AC 0.5A (resistive load), Form A contact

### External contact input

Type : Run, Hold, Step, Reset  
Input method : Non voltage contact input  
OPEN :  $500\text{k}\Omega$  or more  
CLOSE :  $10\Omega$  or less

# Ramp/Soak temperature controller REX-P300

## Options

### External contact input

- Type : Start pattern number setting (4-bit binary contact)  
Input method : Non voltage contact input  
                  OPEN : 500k $\Omega$  or more  
                  CLOSE : 10 $\Omega$  or less

### Auxiliary output

- Number of outputs : Up to 3 points  
                          (The number of outputs varies with the specification.)  
Output type : Programmable  
                  (Process high alarm, Process low alarm, Set Value high alarm, Set Value low alarm, Pattern end signal, Soak state signal, Hold state signal, RUN state signal)  
Output : Relay output, Form A contact 250V AC 0.5A (resistive load)

### Analog output

- Number of outputs : 1 point  
Output signal : 0 to 10mV, 0 to 100mV DC  
                  (Load resistance : More than 20k $\Omega$ )  
                  0 to 1V, 0 to 5V, 0 to 10V, 1 to 5V DC  
                  (Load resistance : More than 1k $\Omega$ )  
                  0 to 20mA, 4 to 20mA DC  
                  (Load resistance : Less than 600 $\Omega$ )  
Output type : Programmable  
                  (Process value, Deviation, Setpoint, Manipulated output value (for heat or cool), Segment time (%))

### Digital communications

- a) Communication method : RS-485 (2-wire), RS-422A (4-wire)  
                                  RS-232C (2-wire)  
b) Communication speed : 1200, 2400, 4800, 9600, 19200 bps  
c) Bit format  
          Start bit : 1  
          Data bit : 7 or 8  
          Parity bit : Without, even or odd  
          Stop bit : 1 or 2  
d) Communication code : ASCII(JIS) 7-bit code

## General specifications

### Supply voltage

- a) 90 to 264V AC (Including supply voltage variation)  
          [Rating : 100 to 240V AC] (50/60Hz common)  
b) 21.6 to 26.4V AC (Including supply voltage variation)  
          [Rating : 24V AC] (50/60Hz common)  
c) 21.6 to 26.4V DC (Ripple rate 10% p-p or less)  
          [Rating : 24V DC]

### Power consumption

- a) Less than 17VA (100 to 240V AC)  
b) Less than 11VA (24V AC)  
c) Less than 310mA (24V DC)

### Effect by power failure

A power failure of 50msec or less will not affect the control action.

### Operating environments

5 to 40°C [41 to 104°F], 20 to 80% RH

### Memory backup

Backed up by EEPROM and non-volatile RAM  
Data retaining period : Approx 10 years  
                          (Depends on storage and operating conditions.)

### Net weight

Approx. 500g

### External Dimensions (W x H x D)

96 x 96 x 100mm

## CVM-4 output converter (Optional)

CVM-4 converts the output types of **4-point** time signal output and a pattern end output from open collector to relay output.

### Input

Open collector output from REX-P300 (parallel signal)

### Output

Time signal output 4 points  
Pattern end output 1 point  
Relay output, Form A contact 250V AC 2A (resistive load)

### Cable length

2 meters (The cable shall be prepared separately.)

### Supply voltage

100/110V, 120V, 200/220V, 240V AC  $\pm$ 10% (50/60Hz)  
•Please specify when ordering.

### Power consumption

Less than 6VA

### Operating environments

0 to 50°C [32 to 122°F], 45 to 85% RH

### Net weight

Approx. 1.5kg

### External dimensions (W x H x D)

67 x 137 x 184mm

## CVM-3C output converter (Optional)

CVM-3C converts the output types of **8-point** time signal output and a pattern end output from open collector to relay output.

### Input

Open collector output from REX-P300 (parallel signal)

### Output

Time signal output 8 points  
Relay output, Form A contact 250V AC 3A (resistive load)  
Pattern end output 1 point  
Relay output, Form A contact 250V AC 2A (resistive load)

### Cable length

3 meters (Model code : W-AT-01-3000)

### Supply voltage

100/110V and 200/220V, 120V and 240V AC  $\pm$ 10% (50/60Hz)  
•Please specify when ordering.

### Power consumption

Less than 8VA

### Operating environments

0 to 50°C [32 to 122°F], 45 to 85% RH

### Net weight

Approx. 1.6kg

### External dimensions (W x H x D)

66 x 184 x 153mm

## SP-1 selector (Optional)

SP-1-16Y is a pattern number selector which can be connected to REX-P300.

### Setting

Digital switch (2-button type), Push switch (Non-lock type)

### Setting range

1 to 16

### Performance

Contact resistance : Less than 200m $\Omega$

### Operating environments

-10 to 50°C [14 to 122°F] (No dew condensation)

### Net weight

Approx. 110g

### External dimensions (W x H x D)

48 x 48 x 100mm

# Ramp/Soak temperature controller REX-P300



## Model and Suffix Code

Specification	Model and Suffix Code																
Model	REX-P300 <input type="checkbox"/> <input type="checkbox"/> <input type="checkbox"/> - <input type="checkbox"/> <input type="checkbox"/> - <input type="checkbox"/> * <input type="checkbox"/> D - <input type="checkbox"/> <input type="checkbox"/> <input type="checkbox"/> - <input type="checkbox"/> <input type="checkbox"/> <input type="checkbox"/> - <input type="checkbox"/> <input type="checkbox"/>																
Control method	PID control with AT Heat/Cool PID with AT Position proportioning action without FBR										F	W	Z				
Input type	See range and input code table <input type="checkbox"/>																
Scale range	See range and input code table <input type="checkbox"/> <input type="checkbox"/>																
Control output (OUT 1)	Relay output Voltage pulse DC mA, V (Code number 4-8)										M	V	<input type="checkbox"/>				
Control output (OUT 2)	Control action F, Z Relay output Voltage pulse DC mA, V (Code number 4-8) *1										N	M	V	<input type="checkbox"/>			
Power supply	24V AC/DC 100 to 240V AC										3	4					
Alarm	Dual alarm <input type="checkbox"/> D																
Contact input	Not supplied Start pattern No. setting input										N	1					
Time signal output	4 points 8 points											4	8				
Auxiliary output	Not supplied Supplied *2										N	S					
Analog output	Not supplied See signal code *1												N	<input type="checkbox"/>			
Digital communications	Not supplied RS-232C RS-422A (4-wire system) RS-485 (2-wire system)													N	1	4	5

\*1 : When voltage/current (DC mA, V) output is selected for Control output2 (OUT2), analog output is not available.

\*2 : When auxiliary output is supplied, up to three (3) auxiliary outputs are available.

The maximum number of auxiliary outputs varies according to the specifications as below:

- For P300 with CE mark, UL and CSA approval, please add the suffix of /CE at the end of the model code.

Specifications	Points
PID control with AT and Analog output	2 points
Heat / Cool PID with AT (Released soon)	2 points
Heat / Cool PID with AT and Analog output (Released soon)	1 point
Position proportioning action without FBR (Released soon)	2 points
Position proportioning action without FBR, with analog output (Released soon)	1 point

### Range and input code table

#### Thermocouple

Input	Code	Range
K	K : 35	-200.0 – 400.0°C
	K : 23	0.0 – 1300.0°C
	K : A4	0.0 – 800.0°F
	K : B4	0.0 – 2400°F
J	J : 27	-200.0 – 400.0°C
	J : 16	0.0 – 1200.0°C
	J : B6	0.0 – 800.0°F
J	J : B5	0.0 – 2100.0°F
	R : 05	0.0 – 1700.0°C
R	R : A5	0.0 – 3200.0°F
S	S : 04	0.0 – 1700.0°C
S	S : A5	0.0 – 3200.0°F
B	B : 04	0.0 – 1800.0°C
	B : A9	0.0 – 3200.0°F
E	E : 17	-200.0 – 200.0°C
	E : 08	0.0 – 1000.0°C
E	E : A6	0.0 – 1800.0°F
	N : 05	0.0 – 1300.0°C
N	N : A4	0.0 – 2300.0°F

Input	Code	Range
T	T : 13	-200.0 – 200.0°C
	T : 19	-200.0 – 400.0°C
	T : 06	0.0 – 400.0°C
	T : B7	-300.0 – 700.0°F
T	T : A7	0.0 – 700.0°F
	W5Re	W : 06
W26Re	W : 04	0.0 – 2300.0°C
	W : A6	0.0 – 2200.0°F
W	W : A8	0.0 – 4200.0°F
	PL II	A : 05
A	A : A5	0.0 – 2300.0°F
	U	U : 04
U	U : B1	0.0 – 1100.0°F
	L	L : 04
L		L : A6
	PR20-40	F : 01
F : A1		0.0 – 3200.0°F

#### RTD

Input	Code	Range
Pt100	D : 21	-200.0 – 200.0°C
	D : 25	-200.0 – 600.0°C
	D : B8	-300.0 – 1200.0°F
JPt100	P : 21	-200.0 – 200.0°C
	P : 26	-200.0 – 600.0°C

#### Voltage and Current

Input	Code	Range
0 – 10mV DC	1 : 01	Scale range is programmable in the range of -19999 to 32000 digits (Default : 0.0 to 100.0)
0 – 100m DC	2 : 01	
-100 – 100mV DC	9 : 01	
0 – 1V DC	3 : 01	
-1 – 1V DC	9 : 02	
0 – 5V DC	4 : 01	
-5 – 5V DC	9 : 03	
1 – 5V DC	6 : 01	
0 – 10V DC	5 : 01	
-10 – 10V DC	9 : 04	
0 – 20mA DC	7 : 01	
4 – 20mA DC	8 : 01	

• Type B and PR20-40 inputs : Accuracy is not guaranteed between 0 and 400°C (0 and 752°F).

• Type N, PLII and W5Re/W26Re inputs: Accuracy is not guaranteed between 0 and 32°F.

• Type JPt100 input : Accuracy is not guaranteed over 500°C.

### Signal code

1	0 - 10mV DC	2	0 - 100mV DC	3	0 - 1V DC	4	0 - 5V DC
5	0 - 10V DC	6	1 - 5V DC	7	0 - 20mA DC	8	4 - 20mA DC

# Ramp/Soak temperature controller **REX-P300**

## CVM-4 output converter

CVM-4 converts the output types of **4-point** time signal output and a pattern end output from open collector to relay output.

Specification	Model and Suffix Code		
Model	CVM-4	– 2	<input type="checkbox"/>
Contact output	With contact output (Without FAIL output)	2	
Supply voltage	100 / 110V AC		1
	120V AC		2
	200 / 220V AC		3
	240V AC		4
	Other		9

\*REX-P300 connection cable is to be prepared by customers.

## CVM-3C output converter

CVM-3C converts the output types of **8-point** time signal output and a pattern end output from open collector to relay output.

Specification	Model and Suffix Code		
Model	CVM-3C	–	<input type="checkbox"/>
Supply voltage	100 / 110V AC and 200 / 220V AC		1
	120V AC and 240V AC		2
	Other		9

\*REX-P300 connection cable (RKC's twist cable) is sold separately. Model code : **W-AT-01-3000**

## SP-1 pattern No. selector

The SP-1 is a pattern number selector for the REX-P300 in connection with the optional contact inputs for pattern set. It simplifies pattern selecting operation by plant floor personnel. On the SP1, as soon as P SET button is pressed after a pattern is selected between 1 and 16, the selected pattern will be set on the REX-P300.

Model Code : **SP-1-16Y** (Pattern setting button provided)  
**SP-1-16N** (Pattern setting button not provided)

# Ramp/Soak temperature controller REX-P300

## External Dimensions and Rear Terminals

REX-P300

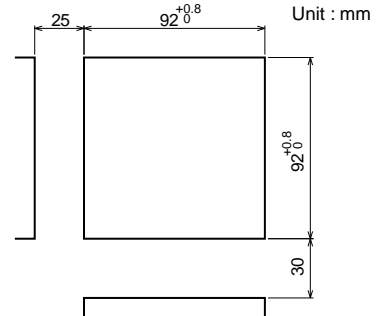
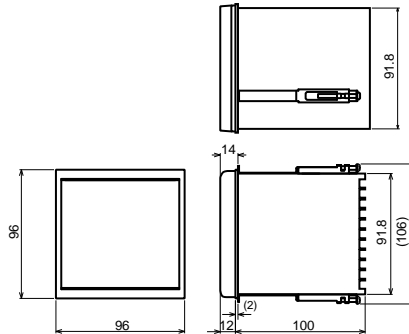
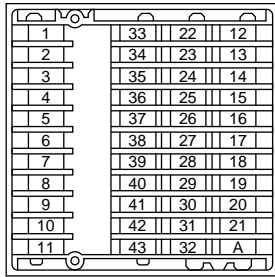

No.	Description	No.	Description	No.	Description	No.	Description
1	AC 100 to 240V	33	COM	22	RS-422A SG	12	Alarm output
2	AC/DC 24V	34	TS5	23	RS-485 T(R)(A)	13	Relay contact output
3	Control output	35	TS6	24	RS-232C T(R)(B)	14	Relay contact output
4	(1) Relay contact output	36	TS7	25	R(A)	15	COM
5	(2) Voltage DC/Current DC	37	TS8	26	R(B)	16	RESET
6	COM	38	NO OUT2	27	COM	17	RUN
7	TS1	39	NO OUT3	28	PTN 1	18	STEP
8	TS2	40	NO OUT4	29	PTN 2	19	HOLD
9	TS3	41	AO+	30	PTN 4	20	Measured input (1) Thermocouple (2) RTD (3) Voltage/Current
10	TS4	42	AO-	31	PTN 8	21	
11	END	43	-	32	P.SET	A	(1) (2) (3)

CVM-4

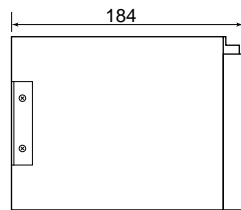
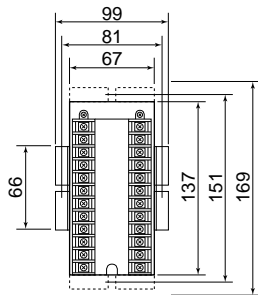

Mounting dimensions

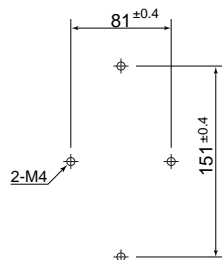

No.	Description	No.	Description
1	G	13	END
2	100/110V or 200/220V AC	14	Pattern end output (Relay contact)
3		15	
4		16	
5	END	17	TS 1
6	TS1	18	TS 2
7	TS2	19	TS 3
8	TS3	20	TS 4
9	TS4	21	
10	COM	22	
11		23	
12		24	

# Ramp/Soak temperature controller REX-P300

## External Dimensions and Rear Terminals

CVM-3C

Unit : mm

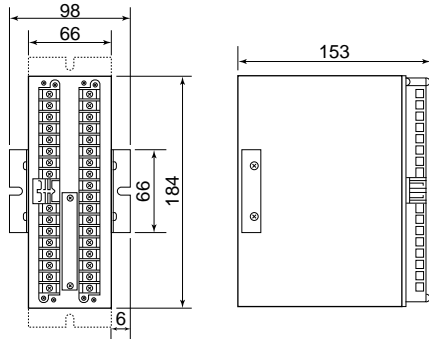

Mounting dimensions

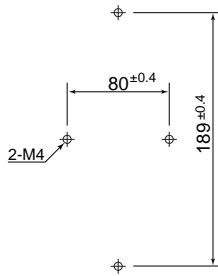

No.	Description	No.	Description	
1	NO ↓	17	NO ↓	
2	C → TS 7	18	C → TS 1	
3	NC ↗	19	NC ↗	
4	NO ↓	20	NO ↓	
5	C → TS 8	21	C → TS 2	
6	NC ↗	22	NC ↗	
7	/		23	NO ↓
8			24	C → TS 3
9	NO ↓ END	25	NC ↗	
10	C →	26	NO ↓	
11	/		27	C → TS 4
12			28	NC ↗
13	 Power supply		29	NO ↓
14			30	C → TS 5
15			31	NC ↗
16	G	32	NO ↓	
		33	C → TS 6	
		34	NC ↗	

SP-1-16

Unit : mm

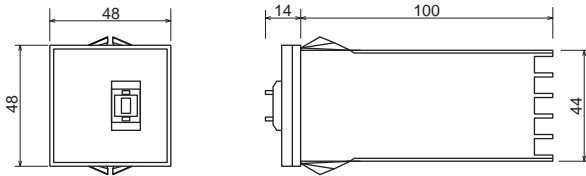

Panel cutout

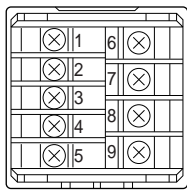
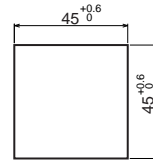

No.	Description
6	—○— P SET
1	— COM
2	—○— 1
3	—○— 2
4	—○— 4
5	—○— 8

Pattern set output (terminals 6, 1)  
 Binary contact signal (terminals 2, 3, 4, 5)